

63-76 Fan Shroud Seals

A 63-65 327 Lower Shroud Seal

Die cut authentic asymmetrical pattern of thick textured surface masticated sheet rubber. Beware symmetrical bogus pattern in replacement materials. Attaches with 5-7 staples. **Exactly** like on my own 1963. 1274201 8.00

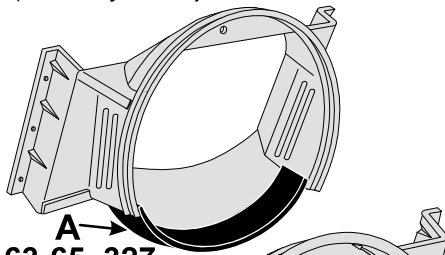

63-65 327

65 396

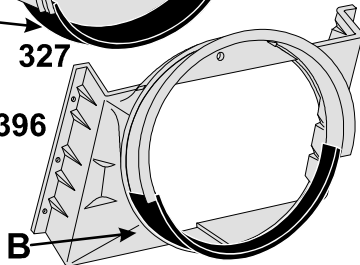

B 65 396 Lower Shroud Seal

Die cut thick textured surface sheet rubber. Attaches with 5-7 staples. 1274203 12.50

C 66-67 AC 427 Upper Shroud Seal

Die cut black sponge rubber mounts to the top rear edge of the fan shroud where it meets the top of the radiator. Install with Black weatherstrip adhesive. It's 50 cents more than others, - but the only one made from the actual GM blueprint. It's Exact. 1274205 5.00

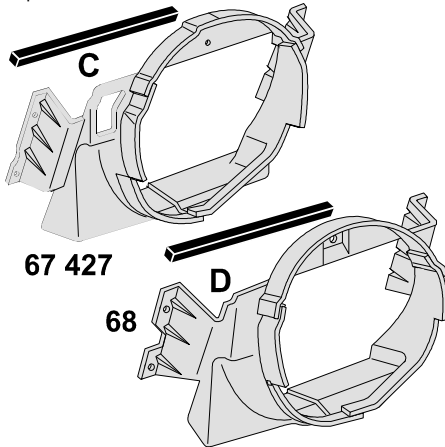

D 68 Plastic Shroud Upper Seal

Use with all Air Cond. models & all 427's with plastic fan shrouds. Die cut sponge rubber with PSA. Use Black weatherstrip adhesive to mount to the top rear edge of the fan shroud where it meets the radiator. It's 50 cents more than others, but the only one made from the actual GM blueprint. It's Exact. 1274406 5.00

E 68-72 Steel Shroud Upper Seal

Use on all models with steel fan shroud. Die cut sponge rubber with PSA. Mounts across the flat top center section of the fan shroud 1274405 5.00

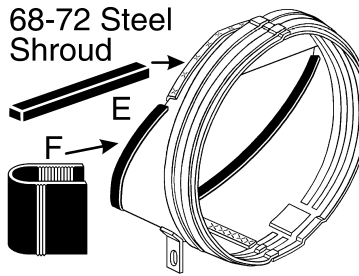

F 68-72 Steel Shroud U-Shaped Seal

Use on models with steel fan shroud. Extruded rubber seal has the authentic deep "U" shaped profile & is authentic down to the **Raised Ribs** on the surfaces, with **11 Ribs** on the inner surface & **3 Ribs** on the outer one. Mounts with 16 staples to the sharp front edge of the steel shroud. I wonder what Zip copied ?? 1274404 14.75

Staple Wire Kits

Authentic gauge wire. Cut wire 1 1/2" long & bend wire 90 degrees every 1/2" **63-65 Kit** Makes 5-7 staples 1274014 2.20 Kit

68-72 Kit Makes 16 staples 1274025 2.50 Kit

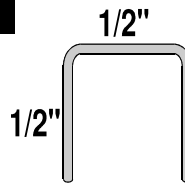

G thru L 69-Early 76 Plastic Shroud Seal 4 Piece Kits

Don't be fooled by the same prices as Zip. We had these made from the actual GM blueprints. They're exact, not a copy. Use on all models with plastic fan shrouds. All sets are die cut Black sponge rubber with PSA. Each set includes a thick narrow upper horizontal seal & thin wide lower horizontal seal. The LH & RH vertical seal are thin and narrow with the LH usually slightly shorter than the RH.

Select from these Models...

- G** 69-72 350 Shroud 4 Piece Seal Set 1274449 18.00
- H** 69-72 427-454 Shroud 4 Piece Seal Set 1274418 18.00
- I** 69-72 Hd Radiator 4 Piece Seal Set 1274426 18.00
- J** 70-72 LT-1 Shroud 4 Piece Seal Set 1274420 18.00
- K** 73 Shroud 4 Piece Seal Set 1274448 18.00
- L** 74-Early 76 Shroud 4 Piece Seal Set 1274422 18.00

Note: Late 76 is after February 25, 1976 production date approximately does not use shroud seals.

69-Early 76

G thru L

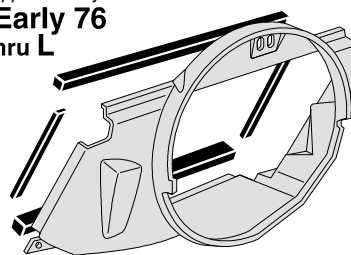

78-82 Auxiliary Fan

- These parts are only used with a "Trap Door" Shroud
- 78-82 Turbine Style Plastic Fan GM disc 1005015 75.00
 - 78-82 Fan To Motor Mounting Nut 1005312 12.75
 - 78-82 Fan Electric Motor disc GM 1005316 105.00
 - 78-81 Fan Harness 2515321 59.95
 - 82 Fan Harness 2515325 59.95
 - 78-82 Fan Harness Mounting Clip 1005310 2.00
 - 78-82 Temp Switch controls fan sold out 1005314 0.00

Fan To Clutch Mounting Kit

- 60-73 Fan To Clutch Hardware 8 Piece Mounting Kit with 4 nuts & 4 lock washers. 1005305 2.00
- 74-82 Fan To Clutch Hardware 4 Piece Mounting Kit Includes 4 Grade 300 bolts. 1005309 6.50

Fan Blades

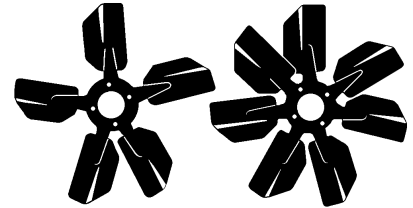

Number of Blades and Diameter

56-Early 57 Fan Blade	4 x 17"	1050210	105.00
Late 57-60 Fan Blade	4 x 17"	1050212	87.50
Late 57-60 Used Factory	4 x 17"	1050001	125.00
60-67 exc AC or 427	5 x 17"	1050002	92.00
64-67 with AC Fan Blade	7 x 17 1/2"	1050214	320.00
65 396 Fan Blade	5 x 17 1/2"	1050216	350.00
66-67 427 Fan Blade	5 x 17 1/2"	1050218	183.50
68 all 327/ 427 Fan Blade	5 x 17 1/2"	1050218	183.50
68-70 except AC, 69 Hiper, AC except 3x2, or 70 350 with AC	7 x 17 1/2"	1050005	Disc
69-70 all except AC	5 x 17 1/2"	1050218	183.50
71-77 350; 78-79 exc AC	7 x 17 1/2"	1005009	122.95
78-82 350 with AC	7 x 18 1/2"	1005011	105.00

Warning

A bent, out of balance fan wobbles & puts excess strain on the wears out the water pump. If the pump shaft lets go, it could damage the radiator and/or fan shroud.

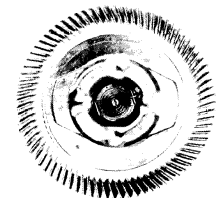

FAN CLUTCH

Aftermarket and OEM Fan Clutches

60-70 all Fan Clutch	1050301	115.00
71-73 All 350 and 454	1050311	119.00
74-76 350 or 454 except AC	1050311	119.00
74-75 350 or 454 with AC	1050312	119.00
76-78 with AC except L-82r	1050313	124.00
76-78 with AC and L-82	1050312	119.00
77-79 exc AC or HD Rad (VO1)	1050311	119.00
77-79 with HD Radiator (VO1)	1050312	119.00
79 350 except L-82 or HD Cooling	1050313	124.00
79-80 with L82	1050314	123.00
80 305 350 except L-82 or HD Cooling	1050313	124.00
80-81 with HD Cooling (VO8)	1050312	119.00
81-82 except HD Cooling	1050314	123.00
82 with HD Cooling (VO8)	1050313	124.00

Genuine Delco Fan Clutches

60-70 all Fan Clutch	1050101	215.00
71-73 All 350 and 454	1050111	0.00
74-76 350 or 454 except AC	1050111	0.00
74-75 350 or 454 with AC	1050112	94.00
76-78 with AC except L-82	1050113	147.50
76-78 with AC and L-82	1050112	94.00
77-79 exc AC or HD Rad (VO1)	1050111	0.00
77-79 with HD Radiator (VO1)	1050112	94.00
79 350 except L-82 or HD Cooling	1050113	147.50
79-80 with L82	1050114	115.00
80 305 350 except L-82 or HD Cooling	1050113	147.50
80-81 with HD Cooling (VO8)	1050112	94.00
81-82 except HD Cooling	1050114	115.00
82 with HD Cooling (VO8)	1050113	147.50

Fan to Water Pump Mounting

Ours include Grade 300 hardware. Ask what's in others

55-60 8 Piece Hardware Kit	1005302	3.50
60 Fan with Spacer 8 Piece Kit GM disc	1005303	9.50
60-62 Fan with Clutch 8 Piece Kit	1005304	3.50
63-68 with Clutch 8 Piece Kit	1005307	3.50
69-82 with Clutch 12 Piece Kit	1005308	8.00

WRINKLED PSA

Beware of sponge rubber seals with **WRINKLED PSA**. If the protective peel-off paper that covers the Pressure Sensitive Adhesive is **WRINKLED** -- you have a Defective Substandard Part. These parts will not stay attached to your fan shroud or radiator support.

WRINKLED PSA allows the adhesive to dry out and pull away from the seals. Shop with confidence when purchasing **DocRebuild's** products -- we apply our own smooth PSA in our own factory. Reject those trashy Shabby Blem Products