













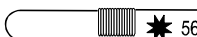







Accelerator Return Springs

Authentic Designs, Appearance
Color Codes and Complete Selection

Special Offer on these >> *

Purchase a second spare of the same spring with
an asterisk ? and the second same spring is **Half
Price**

	53-55 6 cyl Silver	3459100	9.00
	55 V-8 Black	3459103	9.00
	56-61 1x4 Green	3459200	8.00
	56-61 2x4 Rear Silver	3459201	8.00
	56-61 2x4 Front Black	3459202	8.00
	57-62 F.I. Primary Black	3459222	8.00
	57-62 F.I. Secondary Silver	3459223	8.00
	62 250-300 HP Green	3459224	8.00
	62-63 340 HP White	3459203	8.00
	63-65 F.I. Blue	3459197	8.00
	63-67 327 Black	3459204	6.00
	65-67 396 or 427 Black	3459205	6.00
	67 327 Auto Lime Green	2 reqd	3459206 8.00
	68-69 1x4 Black	3459207	8.00
	68 Tripower Yellow	3459208	8.00
	69 Tripower Orange	3459211	8.00
	70-72 All Black	3459214	8.00
	73 All Black	3459215	8.00
	74-82 All Inner Silver	3459212	4.00
	74-82 All Outer Blue	3459213	4.00

Accelerator Spring Bracket

A 55-56 1x4 Bracket	3459105	12.00
B 57-61 1x4 Bracket 1 reqd. , or 56-61 2x4 Bracket 2 reqd.	3459106	9.00
57-58 F.I. Bracket	3459250	29.95
58 F.I. Bracket "S" Link Extension	3459251	8.50
59-62 F.I. Bracket	3459252	14.00
B 62 Early 250, 300 HP Bracket	3459106	9.00
C 62 Late 250, 300 HP Bracket	3459108	9.95
<i>Late is after March 7, 1962 approximately.</i>		
D 62 340 HP Bracket	3459107	11.75
63-65 F.I. Bracket	3459253	20.00
C 63-67 327 Bracket except F.I.	3459108	9.95
E 65-67 396 or 427 Bracket	3459109	9.95
F 69 3x2 Bracket mounts to carb front stud on LH side with spring hole hanging down	3459110	9.00

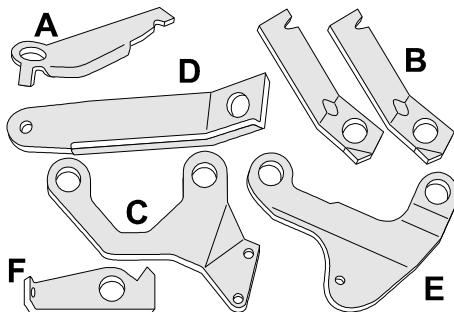





Accelerator Rods plus

Authentic Designs & Appearance
Zinc Plated Very Fine Thread
Ours are Made in USA



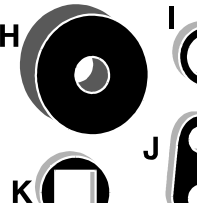

55-62 1x4 Accelerator Rod	3459256	14.95
55-62 Accelerator Lever on Firewall	3459257	20.00
55-61 2x4 Accelerator Linkage Kit includes 2 threaded rods with long adjuster nut, clevis, swivel, bushing, sleeve, clip, springs & brackets. Does both carbs	3459258	59.75
57-65 WCFB Accelerator Pump Rod	3459254	15.50
63-65 327 except F.I. Accelerator Rod	3459259	20.95
63-65 with F.I. Accel Rod OEM not repro	3459260	19.95
Note: the following 65-67 accelerator rods include the welded on spring attachment mounting tab as required.		
65-66 396 or 427 Accelerator Rod		
All 427 before January 1, 1966	3459261	25.00
66 427/425 HP Accelerator Rod		
All 425 HP after January 1, 1966	3459262	28.00
66-67 427/390 HP Accelerator Rod NOS	3459263	45.00
66-67 all 327 Accelerator Rod NOS	3459264	30.00
67 all 427 with 3x2 Accelerator Rod	3459265	45.00
67 all 427 with 3x2 Accelerator Linkage Kit includes 2 threaded rods with special long adjuster nuts, clevis bolt & lock nut, 2 White plastic washers & sleeve (actually modern no stick Teflon) LH & RH end clips. Does 3 carbs	3459266	41.75
68-69 all Accelerator Lever at Firewall	3459269	23.45
68-69 all 427 with 3x2 Accelerator Linkage Kit complete with replacement LH & RH end clips that will not interfere with intake manifold. Does 3 carbs	3459268	45.00
68-69 all 427 with 3x2 Accelerator Linkage Kit includes 2 threaded rods with special long adjuster nuts, clevis bolt & lock nut, 2 White plastic washers & sleeve (actually modern no stick Teflon) with authentic LH & RH end clips which will not interfere with intake manifold. Does 3 carbs NOS discontinued	3459267	55.00

Accelerator Firewall Seals

All are Die Cut Sponge Rubber or Felt
68-82 have Pressure Sensitive Adhesive

	G 53-55 6 Cyl Felt Firewall Seal	3425101	4.50
	H 55-62 V-8 Sponge Firewall Seal	3425106	3.50
	I 63 Sponge Firewall Seal	3425102	3.00
	J 68-73 Oval Firewall Seal	3425231	3.50
	K 74-81 Round Firewall Seal	3425233	3.50

56-67 Accelerator Rod Mount

	L 56-67 Accelerator Rod Swivel		
	Genuine GM Swivel real factory part	3425109	15.50
	Genuine ≠ Repto Swivel	3425198	5.00
	M Nylon Sleeve Pair mount one at either end of the accelerator rod.	3425108	4.50
	N Rubber Bushing Pair mount one at either end of the accelerator rod.	3425107	4.50
	O Accelerator Swivel Cotter Pin & Washer		
	56-62 Cotter Pin & Washer	3425104	1.95
	63-67 Cotter Pin & Washer	3425103	1.95
L+M+N+O Genuine ≠ Repto Kit	3425196	10.00	
63-67 Firewall Accelerator Bushings mount on either end of the accelerator firewall rod. Pair	3425125	4.75	

**68-82 Accelerator Cable
Brackets & Hardware**

68-73 Accelerator Cable can be used as a functional replacement for Late 69 3x2 NOS	3425200	37.50
68-73 Accelerator Cable China repro	3425197	26.50
Late 69 Accelerator Cable with 3x2 Select from...		
NOS with Black Sleeve	3425223	Disc
NOS with Orange Sleeve	3425224	0.00
74 Accelerator Cable Repto	3425201	29.75
75-81 Accelerator Cable Repto	3425202	49.95
82 Accelerator Cable NOS	3425203	75.00
68-69 Under Dash Accelerator Pedal Rod Support		
This is the plastic support under the dash that always breaks leaving you stuck! The original GM part # was 3921618.	3425252	42.50
69-76 Under Dash Pedal Rod	3425250	24.50

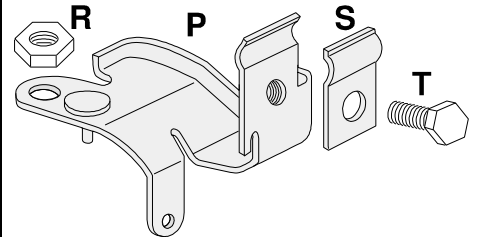

Accelerator Cable Mounting Brackets
Attach to the rear of the carb.

68-69 Tripower Only Cable Mounting Bracket		
Holley 3x2 Cable Mounting Bracket	3459255	29.95
P 68-73 except Hiper 327, 350 or 454 NOS		
Q-Jet Cable Mounting Bracket	3459209	60.00
Q 68-72 with Hiper 327, 350 or 454 NOS		
Holley Cable Mounting Bracket	3459210	0.00

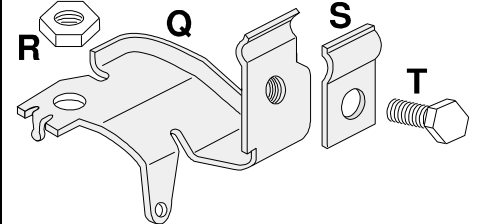

R 68-73 Accelerator Bracket Mtg Nut	3425213	0.90
S 68-73 Cable Mounting Clamp This small clamp is often lost or misplaced, purchase a second spare clamp at Half Price.	3425199	5.00
T 68-73 Cable Mounting Bolt	3425225	0.95
U 68-73 Cable Mounting Stud on Carb Bell Crank includes mounting nut.	3425204	7.00

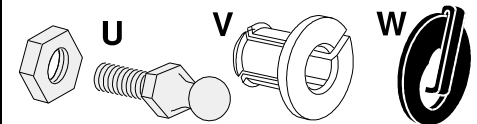

V 68-82 Accelerator Cable Clip to Gas Pedal If this clip breaks, You Are Stuck! Always carry a spare in your glove box.	3425214	4.50
68-73 Underdash Mounting Bolt	3425205	0.95
74 Accel Cable Mtg Brkt NOS	3459235	Disc
75-80 Accel Cable Mtg Bracket	3459237	22.50
81 Accelerator Cable Mtg Bracket	3459239	22.50
82 Accelerator Cable Mtg Bracket	3459241	Disc
W 74-82 Cable Clip to Carb If this clip breaks, You Are Stuck! Always carry a spare in your glove box.	3425222	2.25

**Please Help Prevent Cruely
to Stray Domestic Animals
Adopt a Stray Dog or Cat**